

DC INPUT A
Jk1

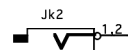

AC INPUT A
C7
1µF

DC INPUT B
Jk3

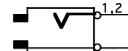
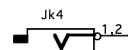
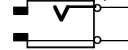

AC INPUT B
C8
1µF

DC INPUT C
Jk7

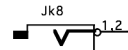
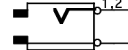

AC INPUT C
C11
1µF

DC INPUT D
Jk9

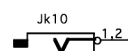
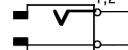

AC INPUT D
C10
1µF

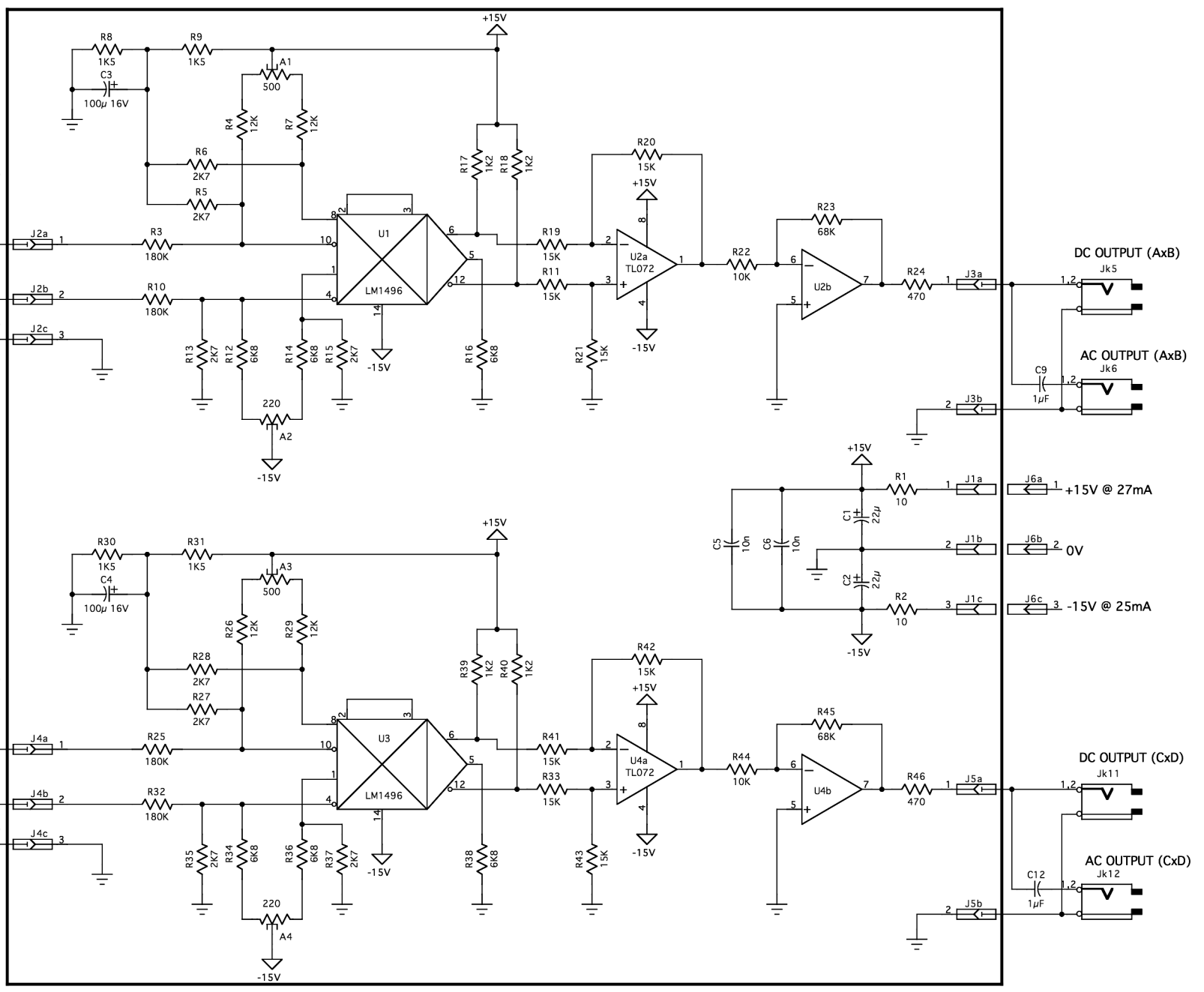

DC OUTPUT (AxB)
Jk5



AC OUTPUT (AxB)
Jk6
C9
1µF

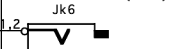

J1a
+15V @ 27mA

J1b
0V

J1c
-15V @ 25mA

DC OUTPUT (CxD)
Jk11



AC OUTPUT (CxD)
Jk12
C12
1µF

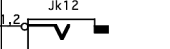

DUAL RING-MODULATOR
drawn by : Yves Usson
november2005